

Jakarta, 15 September 2022

No. : SPH/TAM/628/IX/2022  
Hal : Penawaran Produk

Kepada Yth.  
**Direktur**  
**Rumah Sakit Mata Undaan**  
Jl. Undaan Kulon No. 19, Surabaya

Dengan hormat,  
Kami dari PT Tarafis Anugerah Medika selaku Distributor eksklusif dari Produk alat kesehatan ingin mengajukan penawaran untuk produk alat kesehatan sebagai berikut, guna memenuhi kebutuhan di **Rumah Sakit Mata Undaan**

- *Price List Terlampir*

Demikian penawaran ini kami buat, atas perhatian dan kerjasamanya kami sampaikan terima kasih.

Contact Person : **Andrik Setiawan**  
HP/WA : **+62 821-4352-4980**

Hormat kami,

  
**PT. Tarafis Anugerah Medika**

dr. Ferdian E. Pratama  
**Director**

**PRICE LIST FIRST PROTEC**

nama produk	merk	Size	Sterilization	isi per/box	HNA/pieces	Discount 15%	Discount + PPN 11%
Ophthalmic drape	First Protec	100x80 Ø7x9	Sterile	Box (100 pieces)	36.400	30.940	34.343
Eye Shield	First Protec		Sterile	Box (150 pieces)	5.350	4.548	5.048
Eye Shield	First Protec		Non-steril	Box (360 pieces)	4.700	3.995	4.434
Surgical Gown with 2 pcs hand towels	First Protec	L	Sterile	Box (38 pieces)	75.000	63.750	70.763
Surgical Gown with 2 pcs hand towels	First Protec	XL	Sterile	Box (36 pieces)	78.500	66.725	74.065
Protection Gown	First Protec	L	Non-steril	Box (50 pieces)	42.500	36.125	40.099
Protection Gown	First Protec	XL	Non-steril	Box (50 pieces)	45.000	38.250	42.458
Mayo cover	First Protec	78x145	Sterile	Box (80 pieces)	54.600	46.410	51.515
Mayo cover	First Protec	60x140	Sterile	Box (48 pieces)	54.600	46.410	51.515
Utility Drape	First Protec	90x100	Sterile	Box (100 pieces)	26.000	22.100	24.531
Utility Drape	First Protec	100x120	Sterile	Box (100 pieces)	31.000	26.350	29.249



TARAFIS



FirstProtect



## 6 Layer SMS Material

New  
Technology

Spunbond outer  
layer for strength

Spunbond outer  
layer for strength

Meltblown  
middle layer as  
bacteria and fluid  
barrier

Meltblown  
middle layer as  
bacteria and fluid  
barrier

Meltblown  
middle layer as  
bacteria and fluid  
barrier

Spunbond inner  
layer for extra  
strength and

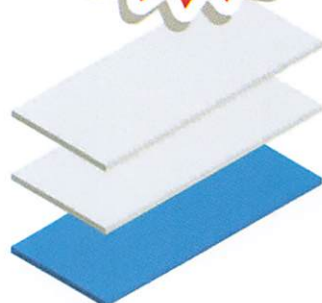
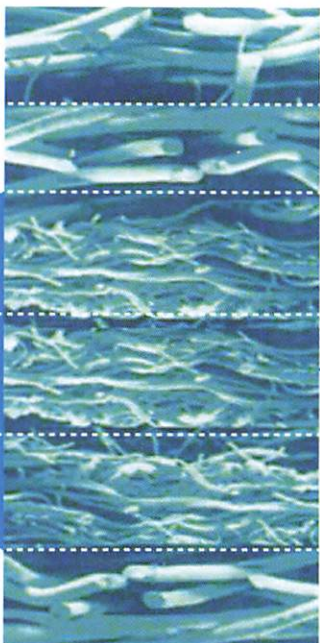

Komponen filtrasi yg penting  
ada pada lapisan **Meltblown**

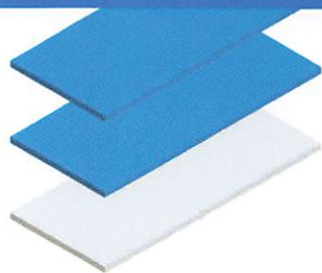

Dengan Teknologi Terbaru  
Menggunakan **6 Layer SSMMMS**  
Dengan **3 layer Meltblown**

**PERTAMA DI INDONESIA**

## Absorbent Material Design in **Surgical Sets**

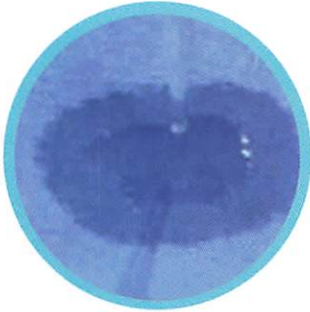

- Material First Protec terdiri dari 2 dan 3 lapis dasar material yang di laminasi memenuhi standard Internasional (En13795)
- Fitur dan Keuntungan:
  - 100% tidak tembus air
  - Daya serap tinggi dan cepat
  - Rendah serat
  - Kuat dan tahan lama
  - Lembut dan lentur
  - Bebas latex

## Absorbent Material Design

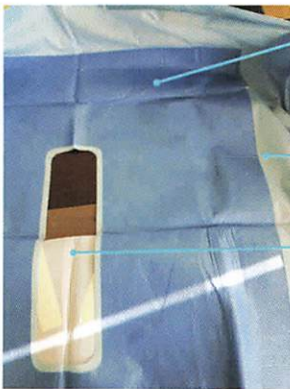

- Patch absorbent paling tebal, di sekitar zona operasi memberikan ekstra absorbent dan kekuatan
- Absorbent lapis kedua yang besar untuk mencegah cairan mengalir
- Lapisan PE Film dengan pelindung kelembaban untuk mencegah tembusnya cairan
- Dengan Hydrohead hingga >140 cm



## Surgical Tapes dari **First Protect**

- Compatible dengan berbagai material drape
- ETO Compatible
- Melekat dengan lembut
- Dapat di buka kembali
- Mudah di aplikasikan dan dilepas kembali setelah dilekatkan
- Tidak menempel pada sarung tangan bedah

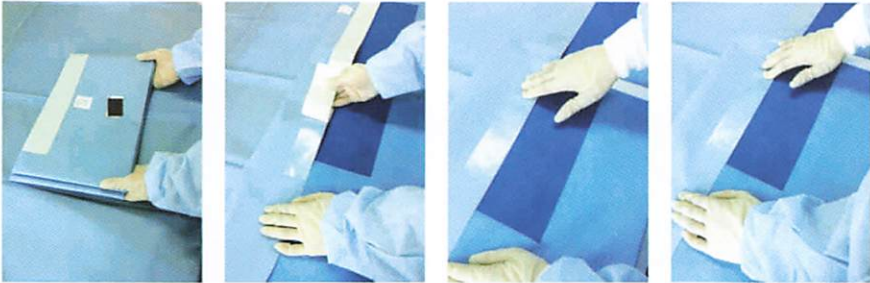

Tidak menempel pada sarung tangan bedah

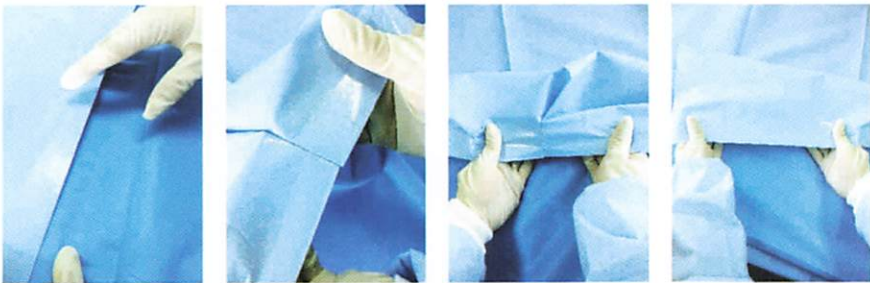

Dapat di buka kembali

Mudah di aplikasi dan dilepas kembali setelah dilekatkan



## SurgicalGown

- Memberikan perlindungan Optimal
- Satu-satunya dengan teknologi 6 layer SSMMMS
- Low lint (Rendah Serat)
- Breathable
- AAMI Level 3 dengan Hydrohead 50 cm
- Jahitan Ultrasonic di seluruh sisi
  - Termasuk lengan dan sisi depan
  - Risiko tembus cairan minimal



KEMENKES RI  
AKL 21603814329

KEMENKES RI  
AKL 21603813980



## Mayo Cover

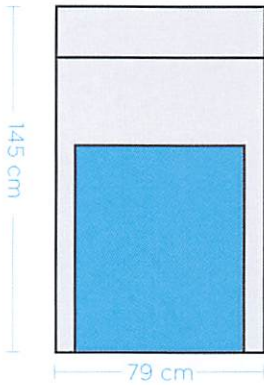

- Ukuran 79 x 145 cm
- Dengan ukuran lebar yang besar sehingga bisa di pakai di semua meja Mayo
- 1 pc/pouch

KEMENKES RI AKL 21603814333

## Legging

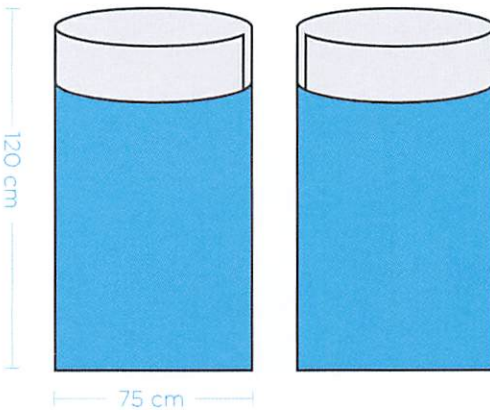

- Ukuran 75 x 120 cm
- 2 pcs/pouch

KEMENKES RI AKL 21603814358



## Ophtalmic Drape

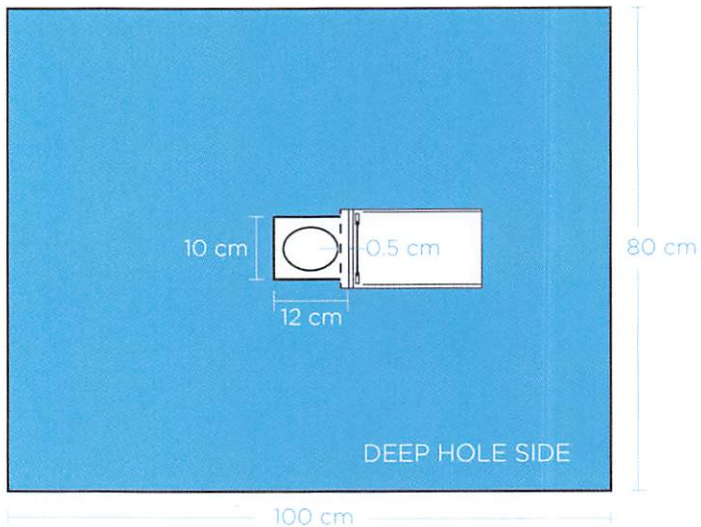

- Ukuran besar, menutupi pasien. Sehingga area steril lebih luas
- Design aperture di tengah memudahkan untuk penggunaan operasi mata kiri atau kanan
- Dilengkapi lapisan film insisi
- Dengan kantong plastic untuk menampung cairan

KEMENKES RI AKL 21603814330

**CABG Set**

<b>Cardiology (CABG) Set</b>	<b>Size</b>	<b>Quantity</b>
Mayo cover	79x145 cm	2
Instrument table cover	150x190 cm	1
OP tape	9x50 cm	2
Hand towel		3
Suture Bag/Instrument Pocket	24x27 cm	1
Suction and diathermy bag	30x40 cm	1
Shoe cover	27/36x20.5 cm	2
Genital Cover	10/35x35 cm	1
Cardiovascular drape	200x350 cm	1
Utility drape	150x120 cm	1
Utility drape	50x60 cm	1
Utility drape	150x160 cm	1

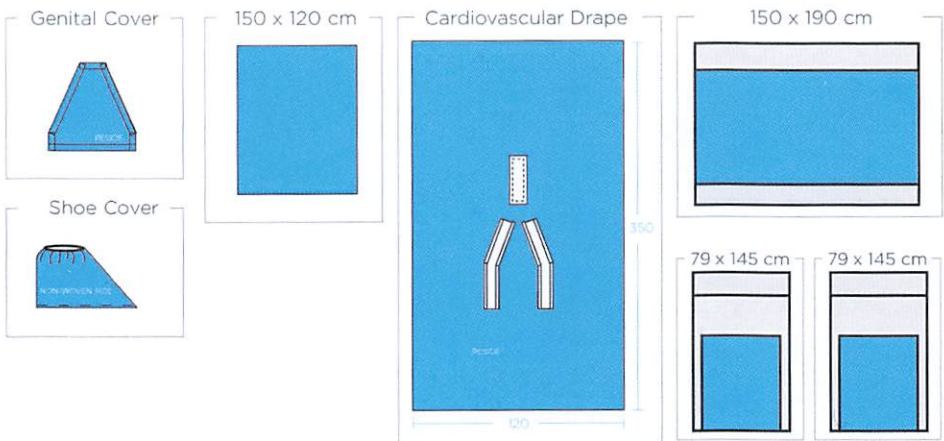

KEMENKES RI AKL 21603814372

**Neurology Set**

<b>Neurology Set</b>	<b>Size</b>	<b>Quantity</b>
Adhesive drape (side)	50X60 cm	4
Utility drape	150x120 cm	2
Neurology drape	264x252 cm	1
Hand towel		2
Mayo cover	79x145 cm	1
Instrument table cover	150x190 cm	1
Instrument table cover	150x190 cm	1
Suction and diathermy bag	30x40 cm	1

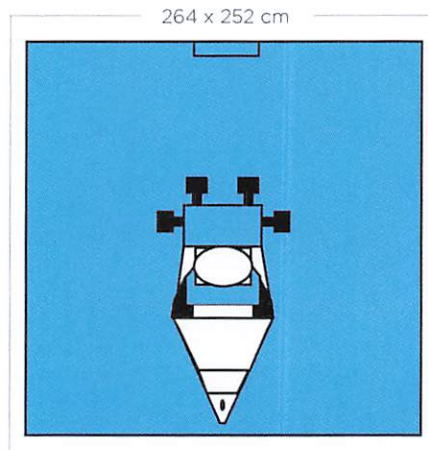
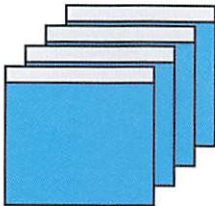
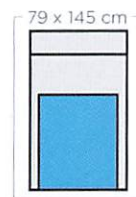
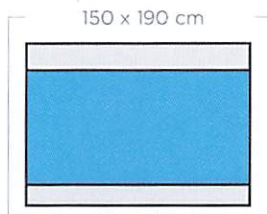
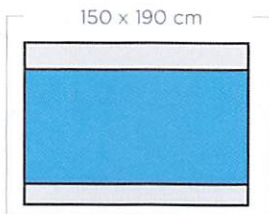



**Universal Set**  
with **3 Surgical Gown**



<b>Universal Set</b>	<b>Size</b>	<b>Quantity</b>
Surgical Gown	L	2
Surgical Gown	XL	1
Hand towels		6
Adhesive drape (side)	100x150 cm	2
Adhesive drape Medium (top)	200x260 cm	1
Adhesive drape Medium (bottom)	180x240 cm	1
Instrument table cover	150x190 cm	1
Utility Drape	90x120 cm	2
Mayo cover	79x145 cm	1
OP tape	9x50 cm	1

**C-Section Set**  
with **3 Surgical Gown**



<b>C-Section Set</b>	<b>Size</b>	<b>Quantity</b>
Surgical Gown	L	2
Surgical Gown	XL	1
Adhesive drape (side)	75 x 90 cm	4
C-Section drape, fluid collection pouch & incision film	180 x 330 cm	1
Baby sheet	75 x 120 cm	1
Hand towels		6
Mayo cover	79 x 145 cm	1
Instrument table cover	150 x 190 cm	1

## Our OEM Factory Partner

### Zhende Medical



Workshop and Facilities





**ISO and International Collaboration**

ISO 9001

ISO 13485

EO Sterilization Certificate



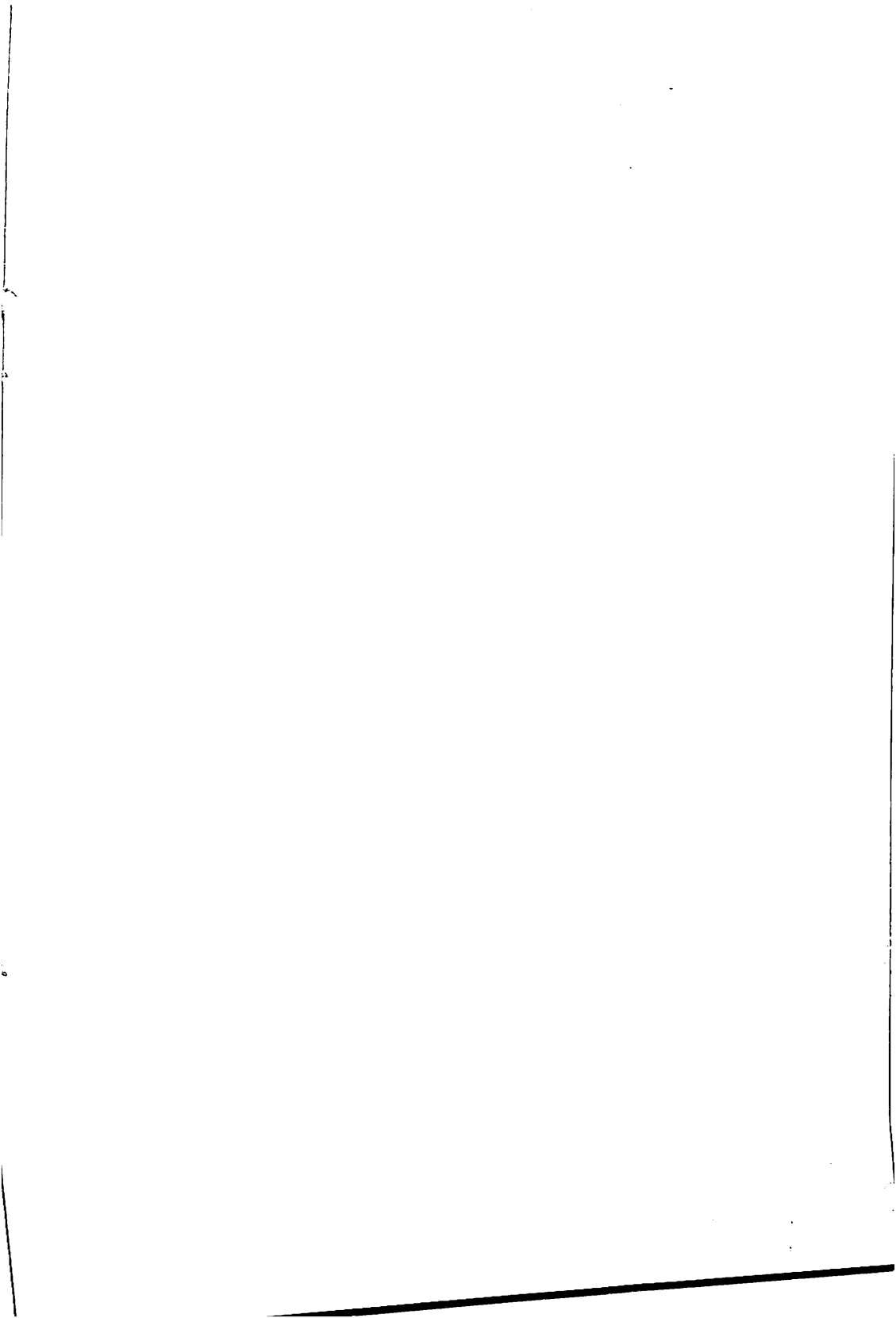



**FirstProtec**

 **TARAFIS**

**PT. Tarafis Anugerah Medika**

Gading Bukit Indah Blok SB/9  
Kelapa Gading, Jakarta 14240  
Indonesia

O : +62 21 290 78825  
F: +62 21 296 29813  
e-mail: [info@tarafis.com](mailto:info@tarafis.com)